



Shoulder Electronics Limited

APPROVAL SHEET

DATE: 2015-12-24

CUSTOMER:

PRODUCTION NAME: CRYSTAL UNIT

PART NUMBER: ZM2012-32.768-9-20/150/E

PREPARED BY: _____ **CONFIRMED BY:** _____

1.ELECTRICAL SPECIFICATIONS

Parameter	Symb	Value	Condition
Frequency Range	F_0	32.768Khz	
Frequency Tolerance	$\Delta f/f_0$	± 20PPM	REF TO 25°C
FREQUENCY STABILITY		± 150PPM	-40°C to 85°C
Turnover temperature	T_m	25 ± 5°C	
Operating Temperature Range	T_{OPR}	-40°C to 85°C	
Storage Temperature Range	T_{STG}	-55°C to 125°C	
Quality factor		60,000TYP	
Series resistance	R_1	90 K Ω	REF TO 25°C
Shunt Capacitance	C_0	1.8PF TYP	0.9~2.0PF
Motional Capacitance	C_1	6.40Ff TYP	
Load Capacitance	C_L	9PF	
Insulator Resistance	IR	500 M Ω	DC100V ± 15 V
Drive Level	DL	0.5 μ W MAX	
Capacitance ratio	r	450TYP	
Aging	$\Delta f/f_0$	± 3PPM	at 25°C ± 3 °C

1.2 DIMENSION Unit:mm

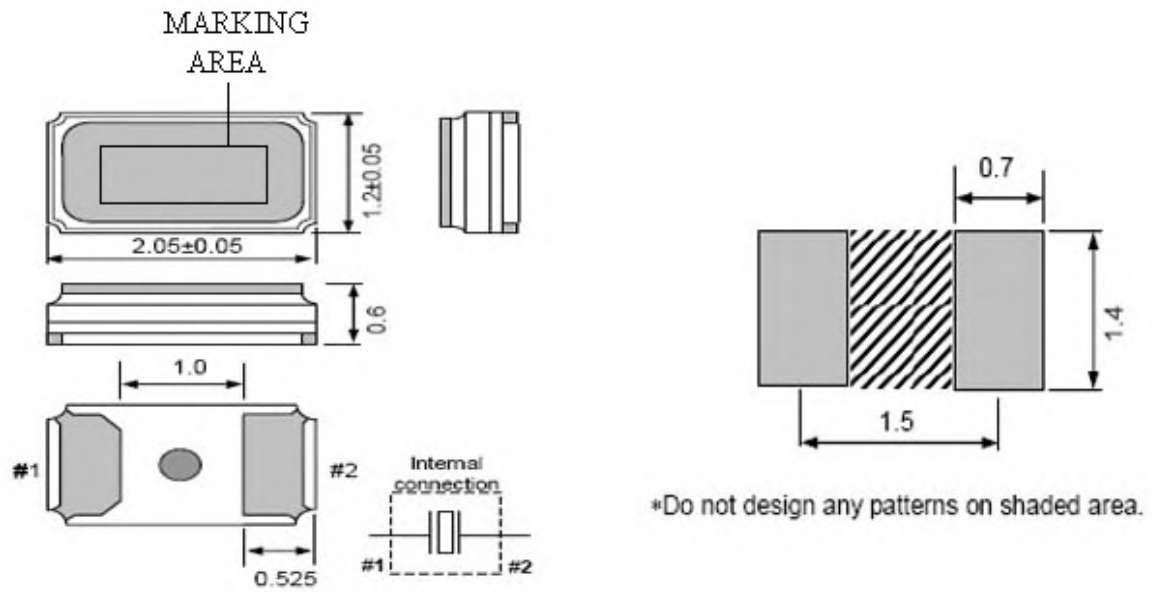

1.3 Reflow solder

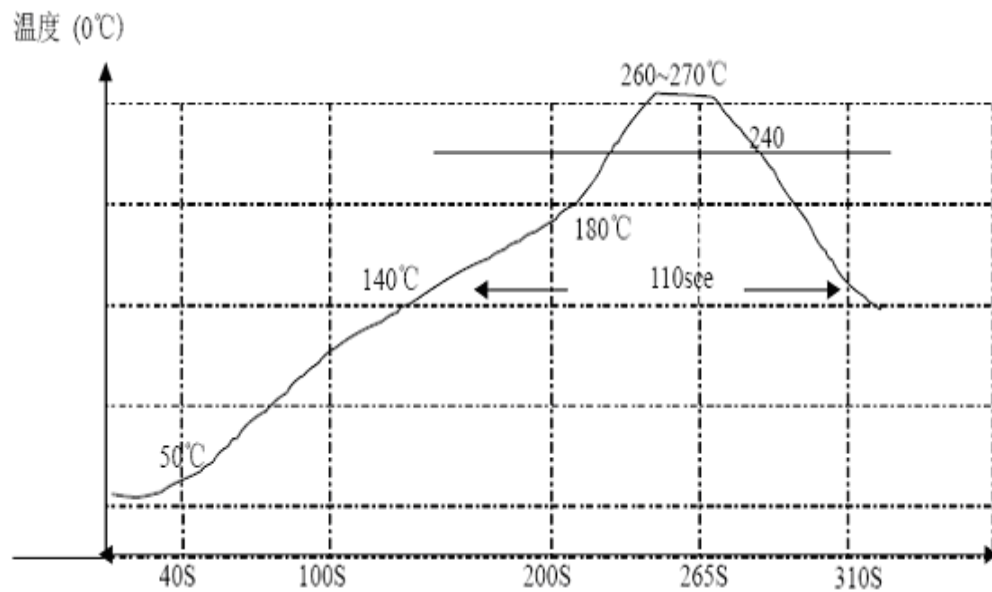

2. TEST STANDARD

2.1 GENERAL ELECTRICAL CHARACTERISTICS AND VISUAL TESTING

2.1.1 LOT CLASSIFICATION : If the quantity is 1,000 pcs or more, 1,000 pcs is one lot.

2.1.2 SAMPLING TEST METHOD : MIL-STD-105E G-II

2.1.3 TEST LEVEL

A) HIGH LEVEL DEFECT : AQL 0.065% [200 PCS]

B) MEDIUM LEVEL DEFECT : AQL 0.25% [50 PCS]

C) LOW LEVEL DEFECT : AQL 0.4% [32 PCS]

2.1.4 DEFECT CLASSIFICATION

A) HIGH LEVEL

@NO FREQUENCY

@MIXING

@LEAK DEFECT

B) MEDIUM LEVEL – ELECTRICAL CHARACTERISTIC DEFECT

@FREQUENCY

@OSCILLATION

@ELECTRICAL CURRENT

@OTHER ELECTRICAL CHARACTERISTICS DEFECT

C) VISUAL

@MARKING

@WELDING

@LEADS

@OTHER VISUAL DEFECT

TESTING METHOD AND ITS STANDARD CAN BE MODIFIED DEPENDING ON THE CUSTOMER'S REQUEST.

2.2 EQUIVALENT CIRCUITS

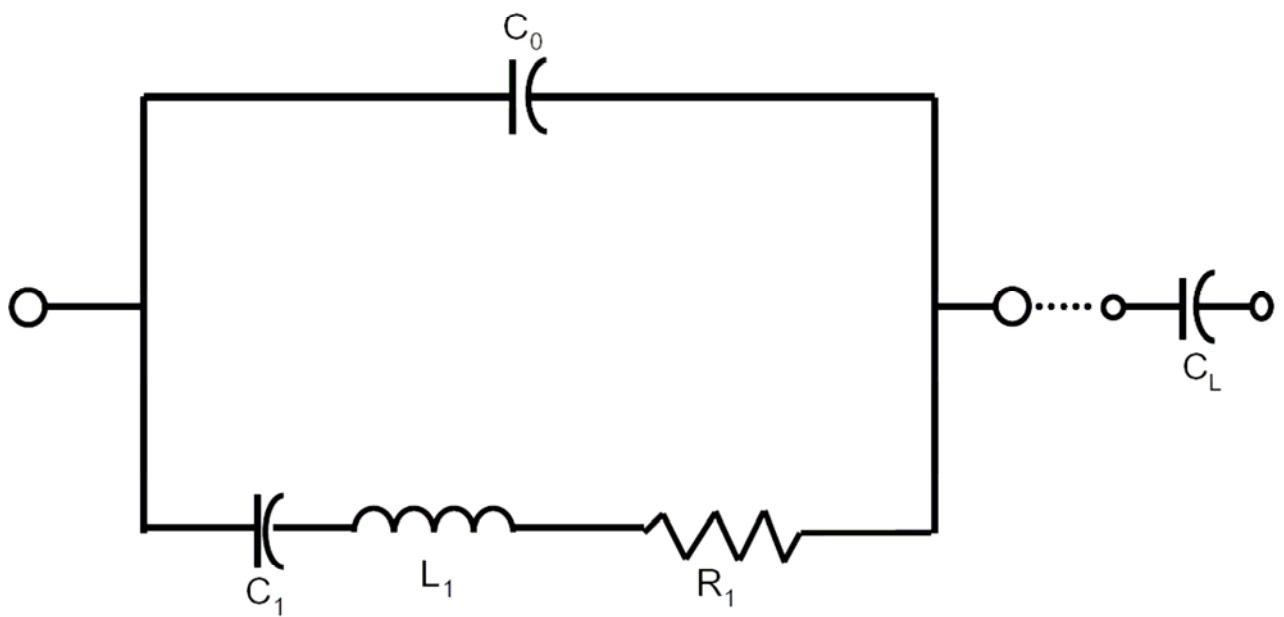
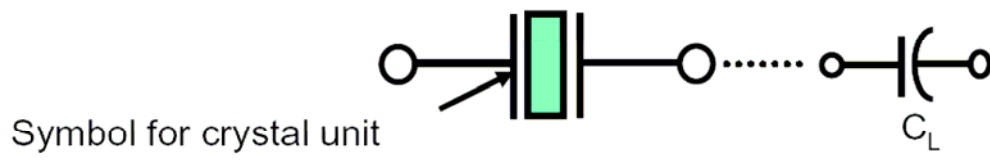

3. RELIABILITY TEST STANDARD

3.1 ENVIRONMENTAL

TEST ITEM	TESTING PROCEDURE & CONDITIONS	EVALUATION
1. THERMAL SHOCK TEST	<p>1. The test should be performed in accordance with the following condition for 10 cycle.</p> <p>2. The crystal unit should be kept in room temperature for 1 hour then tested.</p>	The crystal unit should fulfill the specified requirements of the electrical characteristics and appearance.
2. HUMIDITY	<p>1. temperature : $+40^{\circ}\text{C} \pm 2^{\circ}\text{C}$ RELATIVE HUMIDITY : 90~95% TEST PERIOD : 48 HOURS</p> <p>2. The crystal unit should be kept in room temperature for 1 hour then tested.</p>	The crystal unit should fulfill the specified requirements of the electrical characteristics and appearance.
3. COLD TEMPERATURE TEST	<p>1. TEMPERATURE : $-40^{\circ}\text{C} \pm 2^{\circ}\text{C}$ TEST PERIOD : 2 HOURS</p> <p>2. The crystal unit should be kept in room temperature for 1 hour then tested.</p>	The crystal unit should fulfill the specified requirements of the electrical characteristics and appearance.
4. THERMAL TEST	<p>1. TEMPERATURE : $+85^{\circ}\text{C} \pm 2^{\circ}\text{C}$ TEST PERIOD : 24 HOURS</p> <p>2. The crystal unit should be kept in room temperature for 1 hour then tested.</p>	The crystal unit should fulfill the specified requirements of the electrical characteristics and appearance.
5. RAPID CHANGE IN TEMPERATURE	<p>1. TEMPERATURE : $+85^{\circ}\text{C} \pm 2^{\circ}\text{C}$ TEST PERIOD : 120 HOURS</p> <p>2. The crystal unit should be kept in room temperature for 1 hour then tested.</p>	The crystal unit should fulfill the specified requirements of the electrical characteristics and appearance.

3.2 MECHANICAL

TEST ITEM	TESTING PROCEDURE & CONDITIONS	EVALUATION
1. LEAD TENSILITY	<ol style="list-style-type: none"> 1. FIX THE UNIT. 2. APPLY 2LB OF WEIGHT AXIS TO THE LEADS. 3. TIME : 5 SECONDS 	SHOULD PASS SEALING AND VISUAL TEST
2. LEAD BENDING	<ol style="list-style-type: none"> 1. ATTACH 1 LB OF WEIGHT TO EACH OF THE LEADS. 2. BENDING ANGLE : 90° (FROM THE NORMAL POSITION TO 45° OPPOSITE DIRECTION) 3. BENDING TIME : 3 SECONDS(EACH DIRECTION) 4. NUMBER OF BENDING : 2 TIMES 	SHOULD PASS SEALING AND VISUAL TEST
3. LEADS SOLDERABILITY	<ol style="list-style-type: none"> 1. DIP THE LEADS INTO FLUX(ROJIN METHANOL) FOR 5 SECONDS 2. DIP THE LEADS INTO 250±5°C 99% Sn DIPPING SOLUTION FOR 5 SECONDS. 	THE DIPPED PART OF THE LEADS SHOULD HAVE 90~95% Sn COATING.
4. SOLDERING HEAT RESISTANCE TEST	<ol style="list-style-type: none"> 1. PERFORM ELECTRICAL CHARACTERISTICS TEST BEFORE STARTING THIS PROCEDURE. 2. DIP THE LEADS INTO FLUX(ROJIN METHANOL) FOR 5 SECONDS. 3. DIP THE LEADS INTO 260±5°C 99% Sn DIPPING SOLUTION FOR 5 SECONDS. 4. TAKE THE UNIT OUT, STORE AT ROOM TEMPERATURE FOR 30 SECONDS THEN MEASURE THE ELECTRICAL CHARACTERISTICS. 	SHOULD PASS SEALING AND VISUAL TEST
5. VIBRATION	<ol style="list-style-type: none"> 1. PERFORM ELECTRICAL CHARACTERISTICS TEST BEFORE STARTING THIS PROCEDURE. 2. THE UNIT SHOULD BE FIXED ONTO A VIBRATING MACHINE AND THEN SHAKEN X.Y.Z DIRECTIONS. VIBRATING FREQUENCY : 10 ~ 55 Hz AMPLITUDE : 0.03 Inch FACTOR TIME : 1 MINUTES TESTING TIME : 30 MINUTES EACH FOR X, Y, Z DIRECTIONS 	SHOULD PASS SEALING AND VISUAL TEST
6. DROP TEST	<ol style="list-style-type: none"> 1. PERFORM ELECTRICAL CHARACTERISTICS TEST BEFORE STARTING THIS PROCEDURE. 2. FROM THE HEIGHT OF 500mm DROP THE UNIT 3 TIMES ONTO A HARD RUBBER SURFACE. 	SHOULD PASS SEALING AND VISUAL TEST
7. LEAK TEST	<p>USE Helium Leak Detector.</p> <p>Bombing PRESSURE : 5kg/cm²</p> <p>Bombing TIME : 2 HOURS</p> <p>LEAK SHOULD BE LESS THAN 1E-8 atm.cc/sec.</p>	GAS OR AIR SHOULD NOT BE DETECTED.
8. MARKING ERASE	SUBMERGE THE UNIT INTO IPA[ISOPROPYL ALCOHOL] SOLUTION FOR 10 MINUTES AND BRUSH THE MARKING 10 TIMES WITH A TOOTH BRUSH.	MARKING SHOULD NOT BE ERASED.